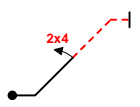
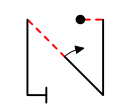
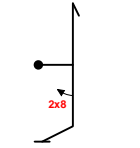
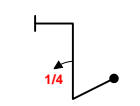
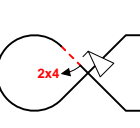
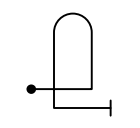
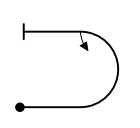
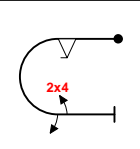
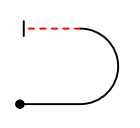
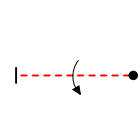
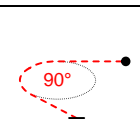

INTERNATIONAL AEROBATIC CLUB SCORESHEET

A	Contest:	Date:	Category:	Programme:	pilot's number	
		2016	Intermediate	Known		

No	Symbol	Catalogue No.	K	Total K	Grade	Remarks
1		1.1.3.1 9.4.2.2	7 7	14		
2		1.3.11.4 9.1.2.2	20 6	26		
3		5.2.1.1 9.8.5.1	17 3	20		
4		1.1.6.1 9.1.1.1	10 6	16		
5		7.3.3.3 9.9.4.4 9.4.4.2	14 11 5	30		
6		8.4.1.1	13	13		
7		7.2.2.1 9.1.3.2	6 4	10		
8		7.2.3.3 9.9.3.2 9.1.3.2 9.4.3.2	6 11 4 5	26		
9		7.2.1.1	6	6		
10		1.1.1.2 9.1.3.4	3 8	11		
11		2.1.1.2	4	4		

Presentation	8	
---------------------	----------	--

FIGURE TOTAL K = 176

INCLUDING PRESENTATION = 184

Aircraft Type:

FREE PROGRAM CHECKED BY:

Signature:	Printed Name:	Date:
		IAC No.

Judge Name:

IAC#

Assistant Name:

IAC#





B	Contest:	Category: Intermediate	
	Date: 2016	Program: Known	Pilot's No. <input type="text"/>

wind direction

Pilot
NAC

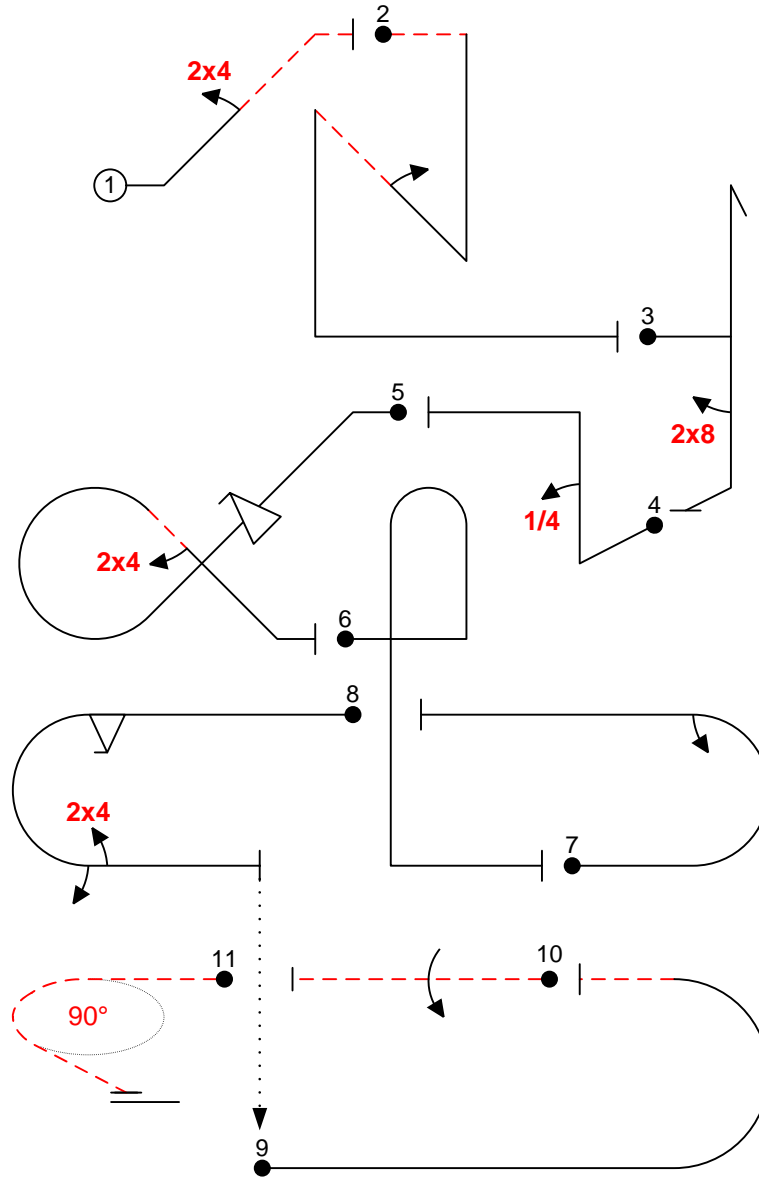

A/C:

FREE PROGRAM CHECK BY: (signature/date)



C	Contest:	Category: Intermediate	
	Date: 2016	Program: Known	Pilot's No. <input type="text"/>

pilot
NAC

wind direction

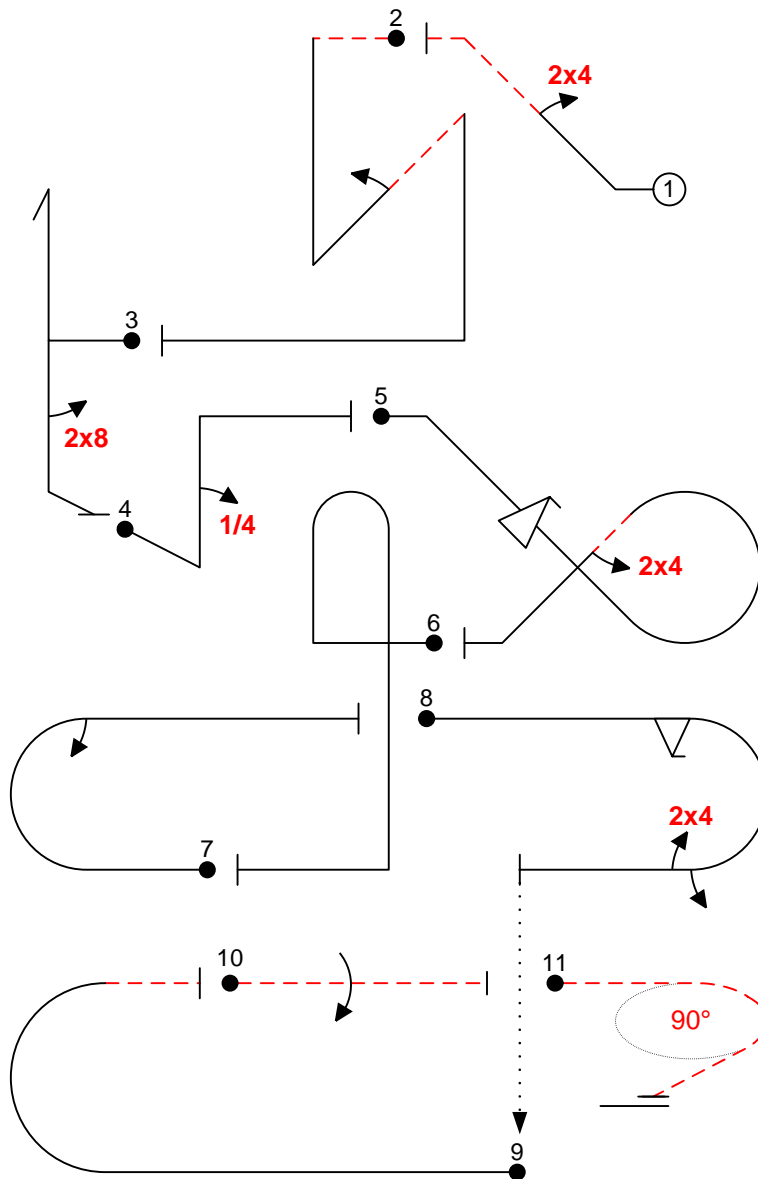

A/C:

(signature/date)

FREE PROGRAM CHECK BY: